

**Canon**



Cardiac & Vascular  
Interventional systems

***Alphenix***

Together,  
Redefine Intervention

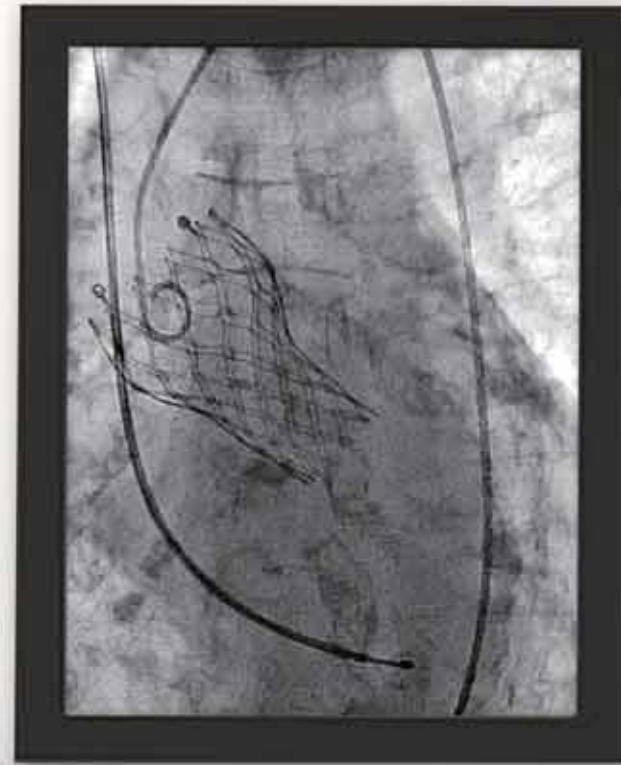
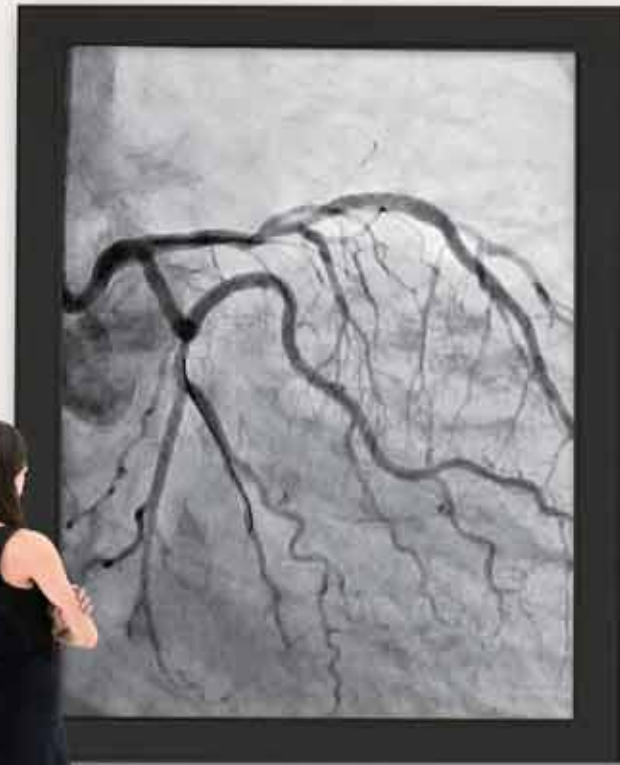

## See New Possibilities Beyond the Image

The new Alphenix family of interventional systems deliver images with greater clarity and precision. Combined with industry-leading dose optimization technologies, enhanced workflow, and a new set of features, Alphenix continues Canon Medical's commitment to supporting you and your mission to provide patients with safe, accurate and fast imaging.



Technology to help you deliver the best possible outcomes for your patient.

**WorkRite**

WorkRite technologies help you optimize workflow and provide an unprecedented range of patient access and coverage.

**ImagingRite**

ImagingRite technologies enable you to deliver high-quality imaging and offer a full complement of fully customizable advanced imaging tools.

**DoseRite**

DoseRite technologies provide a comprehensive dose management suite of tools designed to help you minimize patient X-ray exposure while maintaining optimum image quality, enabling you to prioritize safe operating conditions for patients and clinical staff.

# Unparalleled flexibility and access to your patient.

Every patient is different. The Alphenix, with its WorkRite technologies, including the C-arm and 5-axis C-arm, provides you with unprecedented access to the patient and flexible anatomical coverage from any angle.

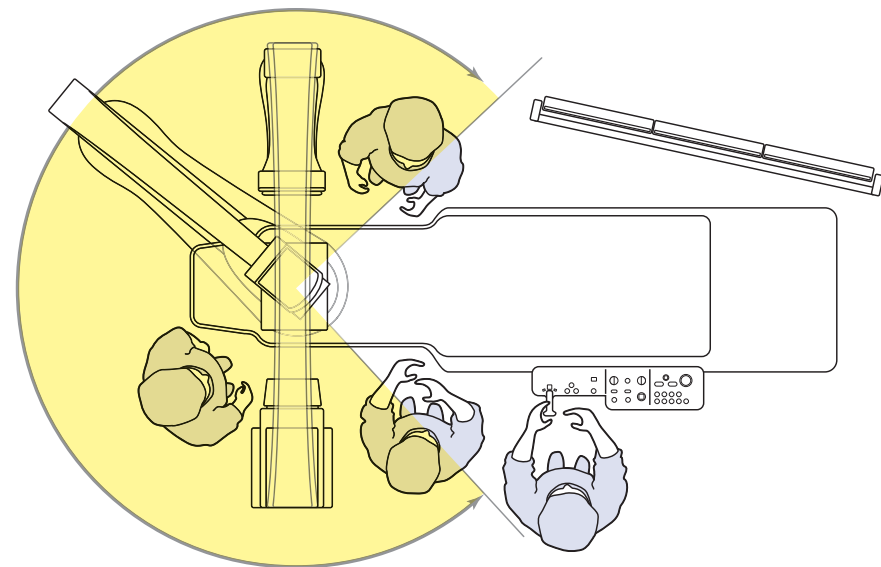

Move the machine, not the patient

*Unique*

*Unique*

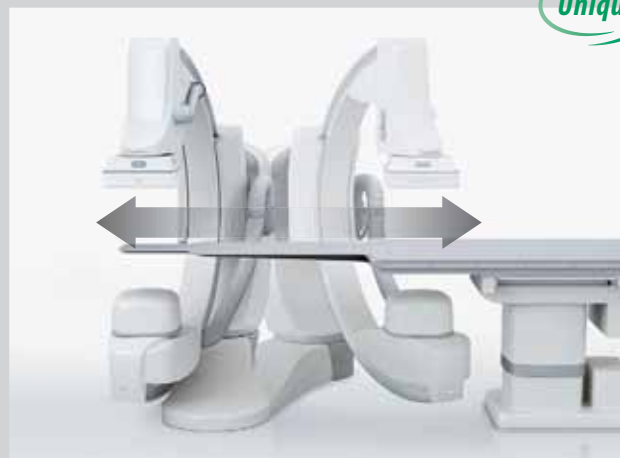

Head-to-toe and fingertip-to-fingertip coverage with multi-access floor-mounted C-arm.

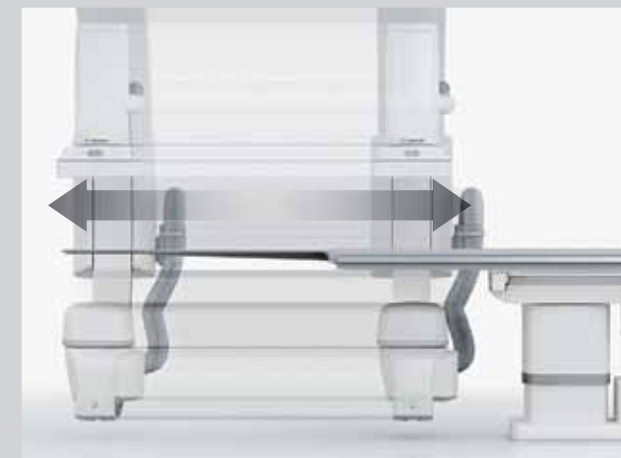

Ceiling-mounted C-arm also provides unparalleled full-body lateral and peripheral access without moving the patient or the table.

# A fast, seamless, and intuitive work experience.

Easily select acquisition protocols and C-arm positions using the tableside Alphenix tablet.



Startup screen

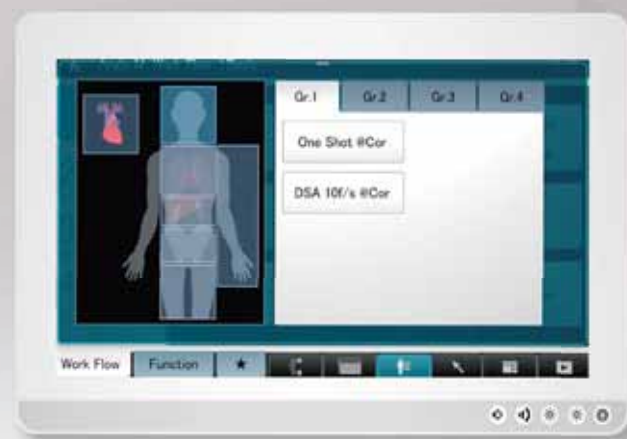

Program tabs



Related functions



Intuitively select the position of the C-arm

# A feature-rich workstation to enhance your productivity

Integrated cardiac-optimized applications help boost productivity.



\* This is a computer generated image



QCA\* features automatic contour detection and analysis of the area of interest. Various calibration options are available, such as Catheter, Sphere, and Distance calibration methods.



3D-QCA\* features reconstructions of stenotic coronary arteries and allows quantitative cross-sectional information to be displayed. This offers automatic contour detection, single-segment analysis, and bifurcation analysis.



Stent Enhancer provides visualization of a stent by suppressing anatomical structures and background noise. To help clinicians further decrease dose, this feature also works with low frame rate acquisitions.

# Navigate with confidence and accuracy.

## Multi-modality fusion\*

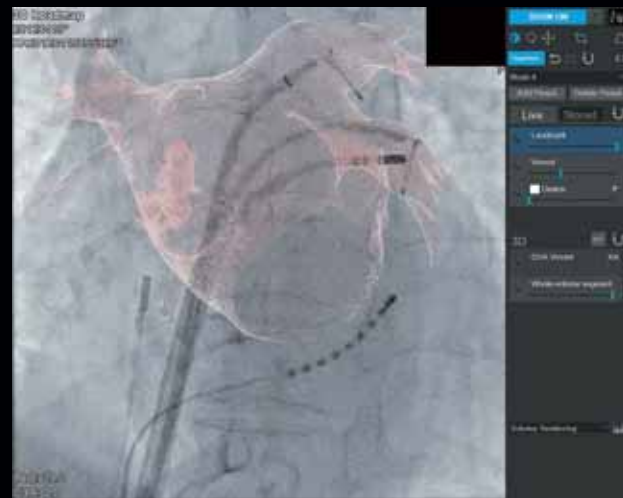

3D fusion technology enables superimposition of 3D volume data on the live fluoro display. Fusion is possible using a C-arm acquired 3D dataset or importing a pre-procedural CT/MR study.

## Valve planning and view angle support\* (3Mensio)



Examples of screenshots for valve planning (left) and view angle support (right).

Comprehensive valve planning software makes pre-implementation analysis possible, allowing quick and intuitive analysis of the aortic valve prior to Transcatheter Aortic Valve Replacement (TAVR).

## IV-LINQ\*

### □ Linkage function between IVUS/OCT

Short axis cross-sectional image

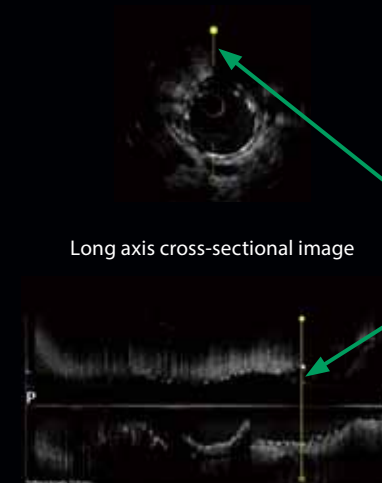

Long axis cross-sectional image

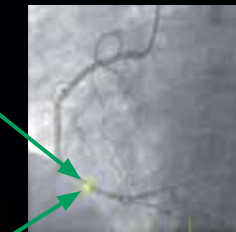

### □ Marking function

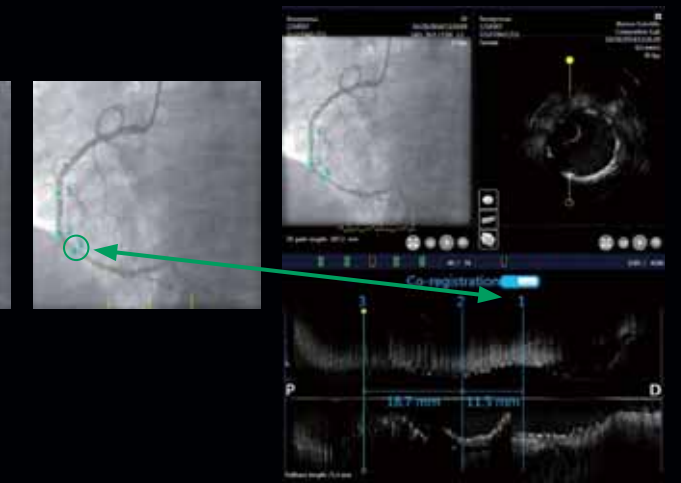

There are two main functions in IV-LINQ. The first is co-registration of IVUS/OCT with the angiographic image. Once registered, the IVUS/OCT position (both short and long axis) can be determined relative to the angiographic image. The second function is the ability to annotate the image with markers, facilitating stent planning and placement.

## Parametric imaging

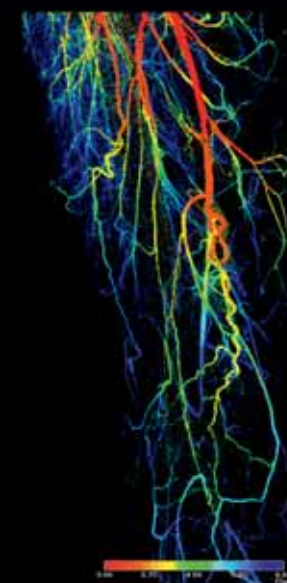

Parametric Imaging uses information from the time density curve to express the timing arrival of contrast medium. Information is assigned at the pixel level. Color values are assigned based on time density curve.

\*: option

Optimize image quality while reducing the exposure dose.

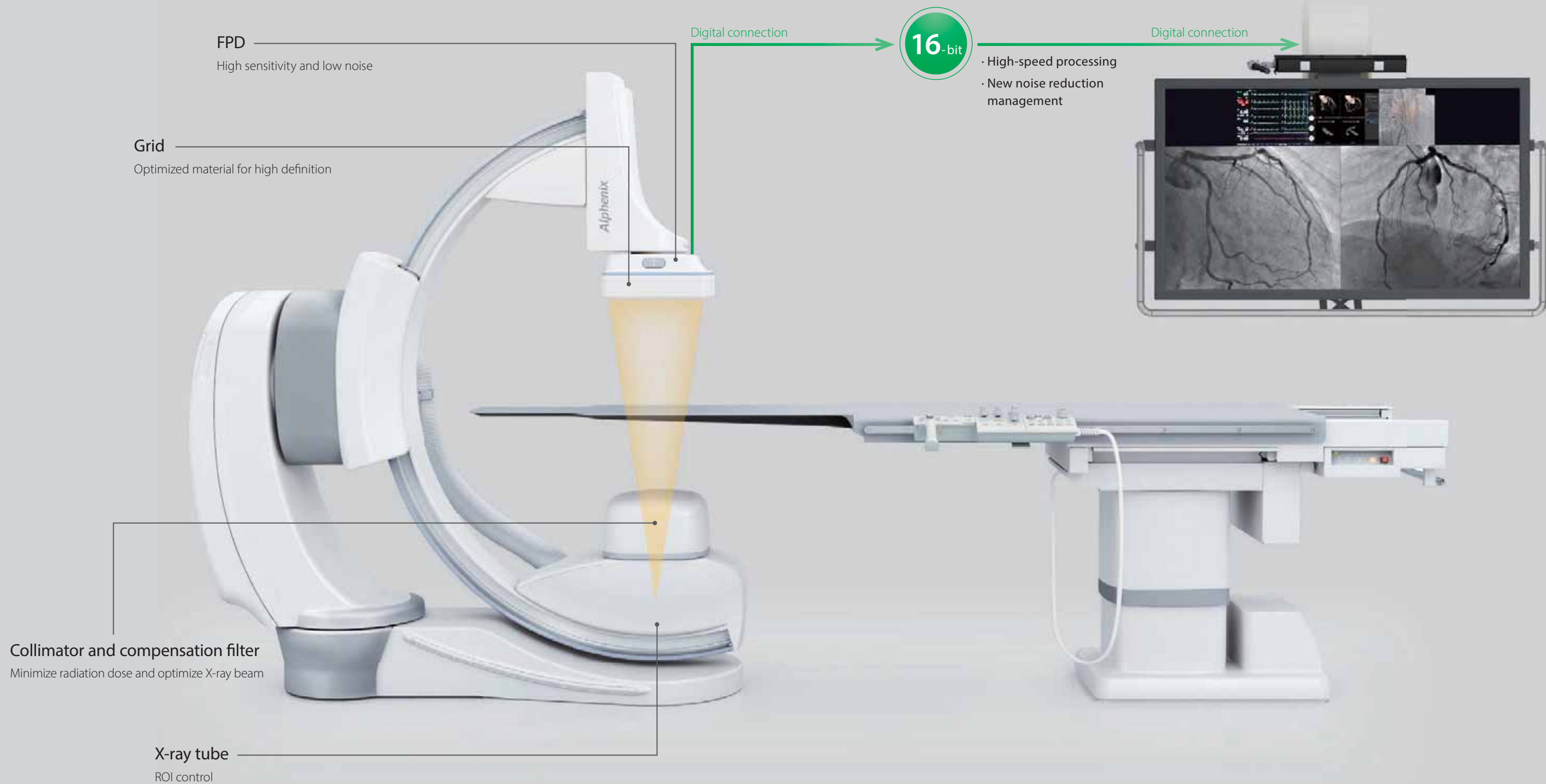



# Powerful imaging and processing tools.

Illuvis technology takes advantage of new hardware and software improvements to reduce noise, enabling you to see through the clutter. Each frame is triple-processed in realtime to reduce background noise and enhance features.

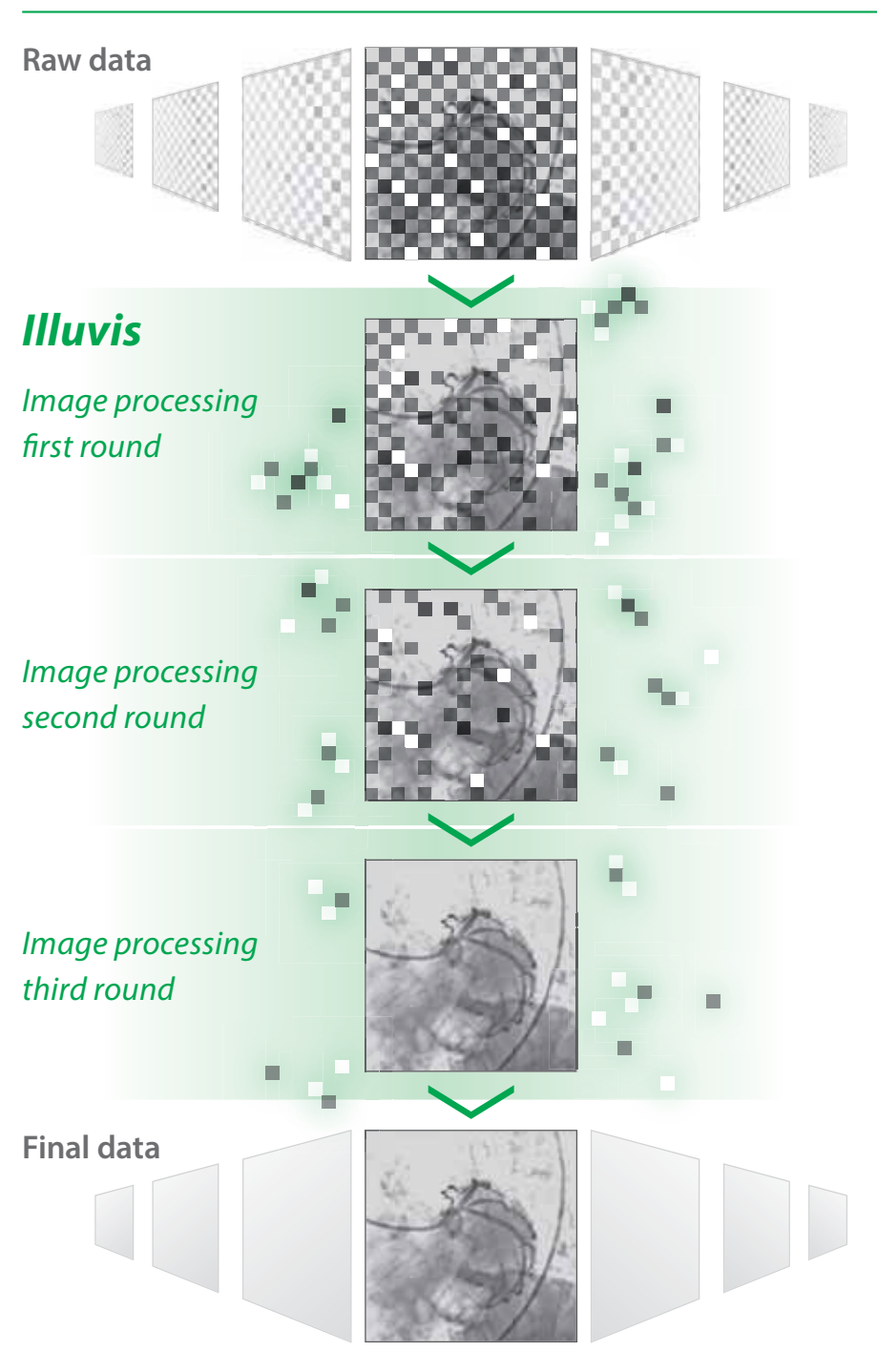

## ROI control

This function automatically senses excessively bright areas in the ROI, such as the lung fields, and excessively dark areas, such as the vertebral bodies and the diaphragm, and calculates the appropriate X-ray conditions.

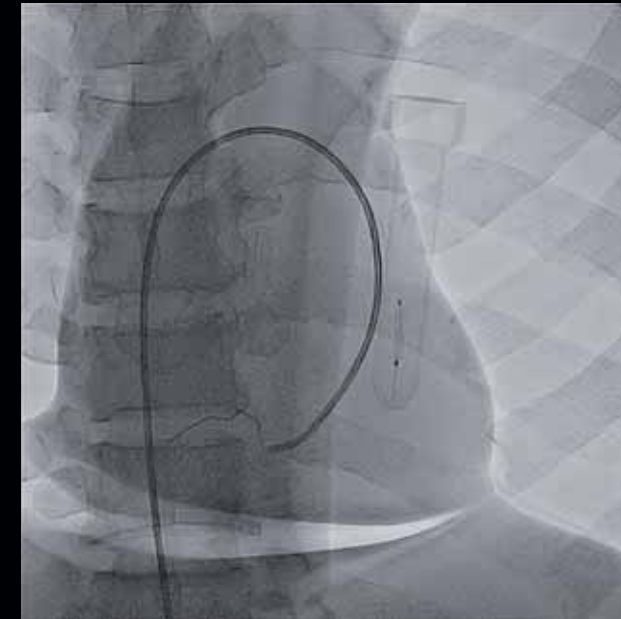

Conventional processing method

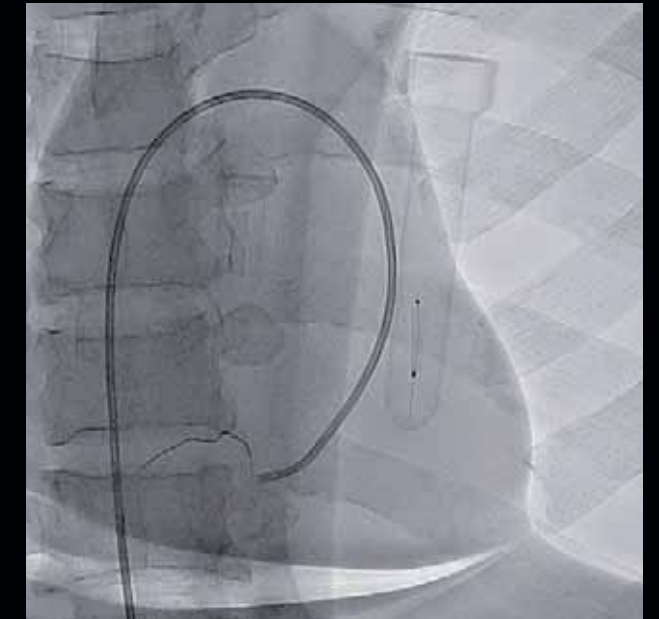

ImagingRite

## Dynamic Trace

In the endovascular treatment EVT area, which is easily affected by direct X-rays, it is possible to acquire vascular images in which the effect of bones overlapping blood vessels is significantly reduced while maintaining stable image quality with no variation in brightness.

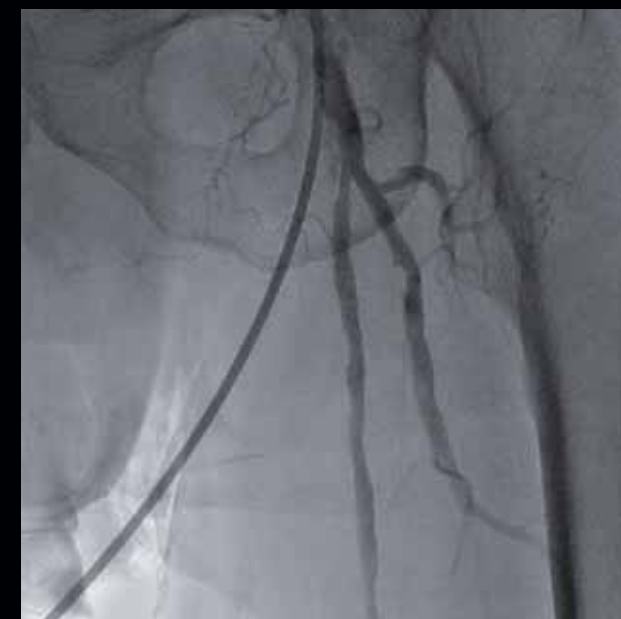

Without Dynamic Trace



With Dynamic Trace

# Optimize exposure dose while delivering high-quality imaging.



A redesigned imaging platform with next-generation AIP and noise reduction technology. Even standard system configurations offer many dose management features to provide benefits for everyone, from patients to clinical staff and management.

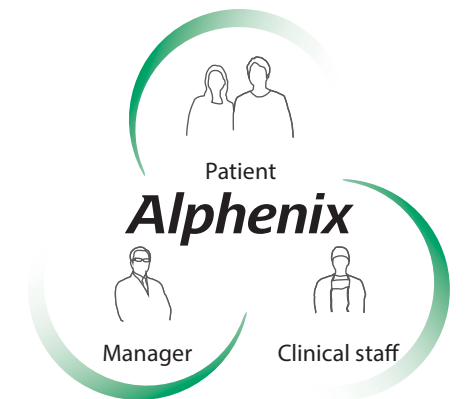

Dose Management for Everyone.

- X-ray beam filter to reduce patient dose and scatter radiation
- Removable grid
- Live zoom to digitally increase image size without performing field of view magnification
- Variable dose mode to pre-programmed combinations of pulse rate, dose level and image processing parameters
- Virtual collimation and filtration to adjust collimation without additional fluoroscopy



 DoseRite PF	 Dose Adjustment Filter	 DoseRite F-Rec	 DoseRite F-Store	 DoseRite Live Zoom	 Virtual Filter/ Virtual Collimator	 DoseRite Position
 Reverse Geometry	 Auto Pixel Shift	 3D Road Map	 DoseRite SPOT ROI	 DoseRite SpotFluoro	 DoseRite DTS	 DoseRite Report

# Asymmetric collimation allows reductions in patient dose.

DoseRite SPOT Fluoro: Industry's first spot fluoroscopy technology. 

Conventional X-ray collimation has two disadvantages: black areas caused by the collimator blades are distracting for the interventionist, and there is an increased exposure dose for the patient because the system compensates for the reduction of scatter radiation due to collimation in the ABC Region of Interest (ROI).

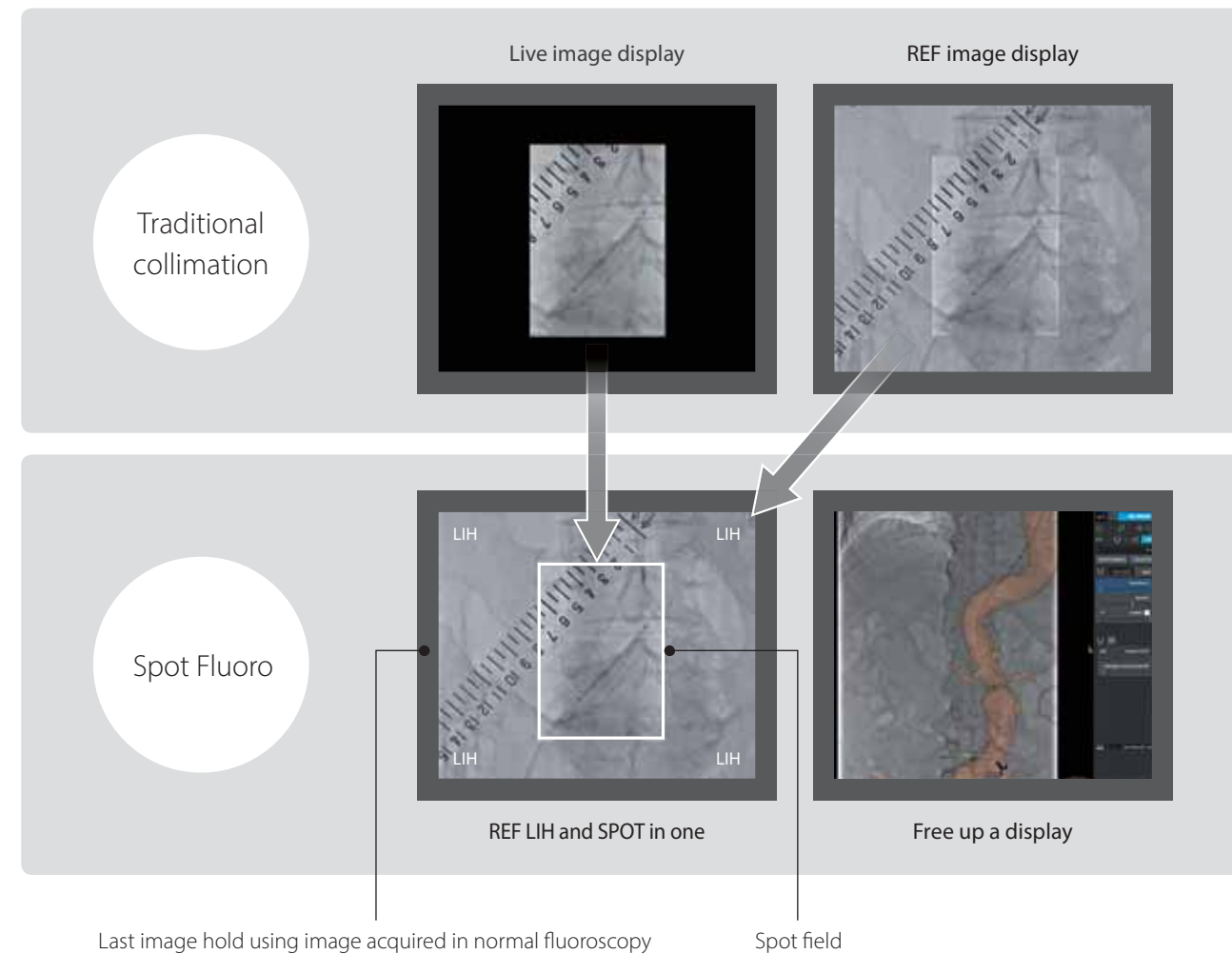

## Reduce DAP with Spot Fluoroscopy

The cumulative DAPs (dose area products) measured on the three selectable live fluoroscopy ROI sizes are shown in the graph on the right (where this is defined as the patient exposure dose). Compared to normal-field fluoroscopy, Spot Fluoroscopy can reduce the dose by more than 50%.

The illustration on the right shows an additional benefit. Spot Fluoroscopy can greatly reduce the overlap between each exposure, saving the patient from unnecessary exposure when different angles are required.

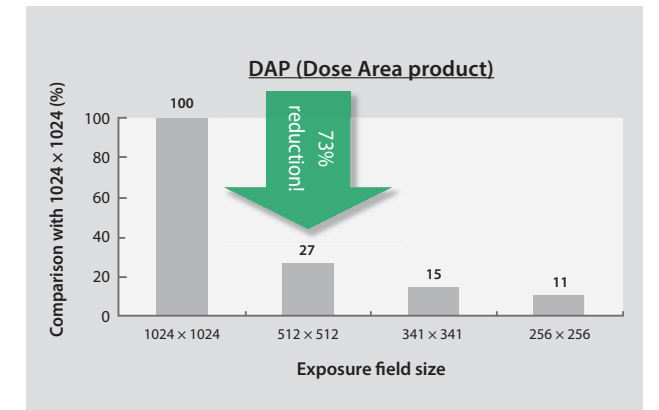
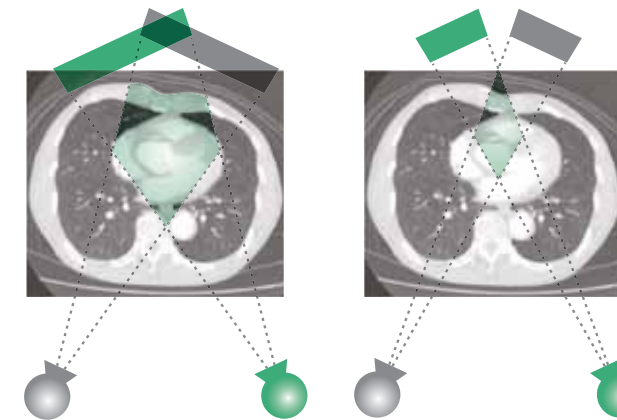

## Reduce exposure of patients, clinicians, and staff

Spot Fluoroscopy realizes a reduction in scatter radiation of more than 50%, as shown in the graph on the right, which is beneficial for clinicians and staff as well as the patient. As these figures show, our exclusive Spot Fluoroscopy minimizes unnecessary exposure and reduces the radiation burden on the patient and clinical staff in the examination room.

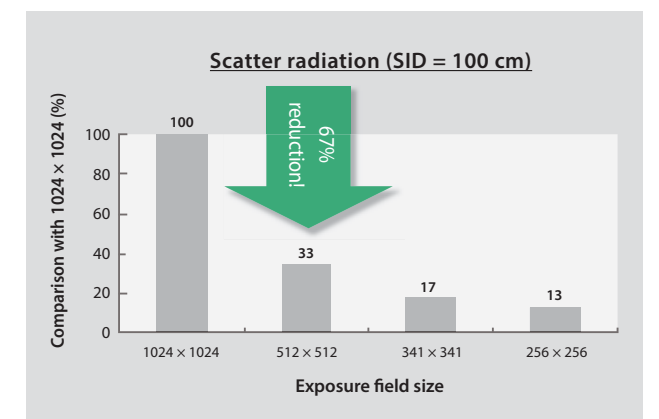

See more of interest,  
with less exposure.

DoseRite SPOT ROI\*

*Unique*

Spot ROI provides dose reduction outside of the region of interest, while still allowing visualization of the surrounding anatomy utilizing an X-ray attenuation filter. During device placement visualization not only of the device, but also the surrounding anatomy is critical for success.

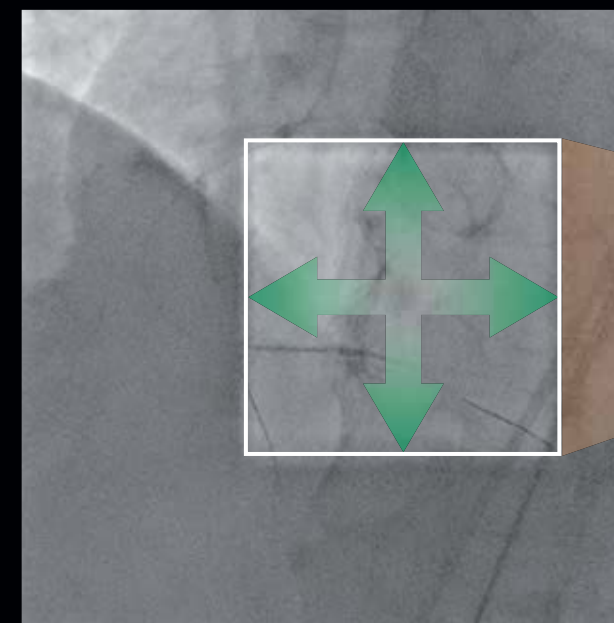
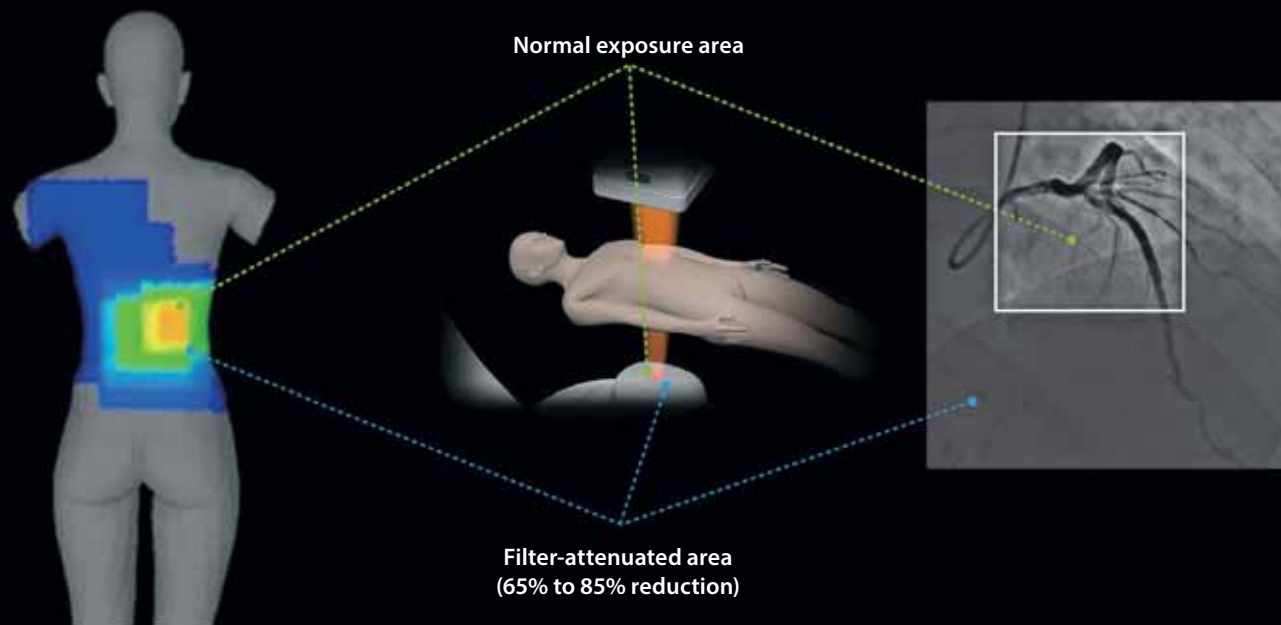

The ROI position can be moved up/down and right/left using this joy-stick button.



\* Only available for Alphenix Core+ and Alphenix Biplane

# Advanced dose management tools

## Fluoroscopic acquisition Unique

Using the footswitch, the operator can capture still and dynamic images for future reference.

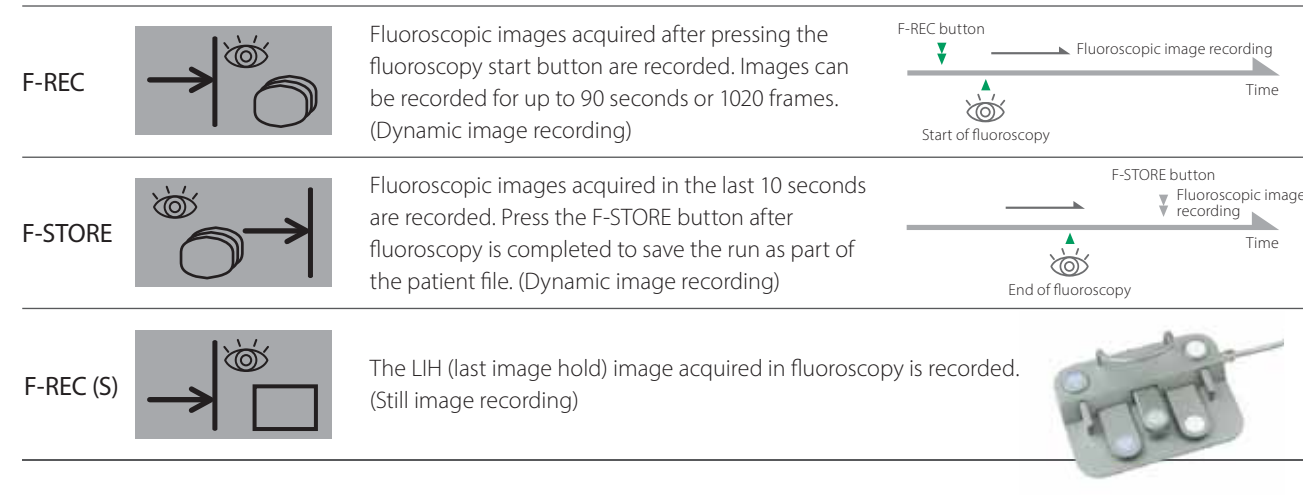

## Realtime display of exposure dose

The operator can observe realtime dose levels on a digital display in the examination and control rooms.

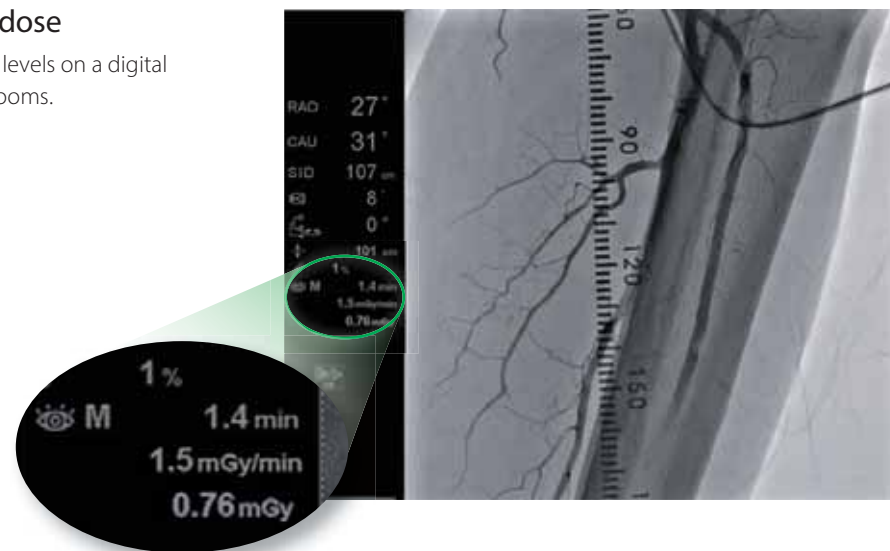

## DoseRite position

Virtual Position provides the desired ROI for the next image using Last Image Hold (LIH) while panning the table or during C-arm movement, enabling the operator to avoid unnecessary X-ray exposure.

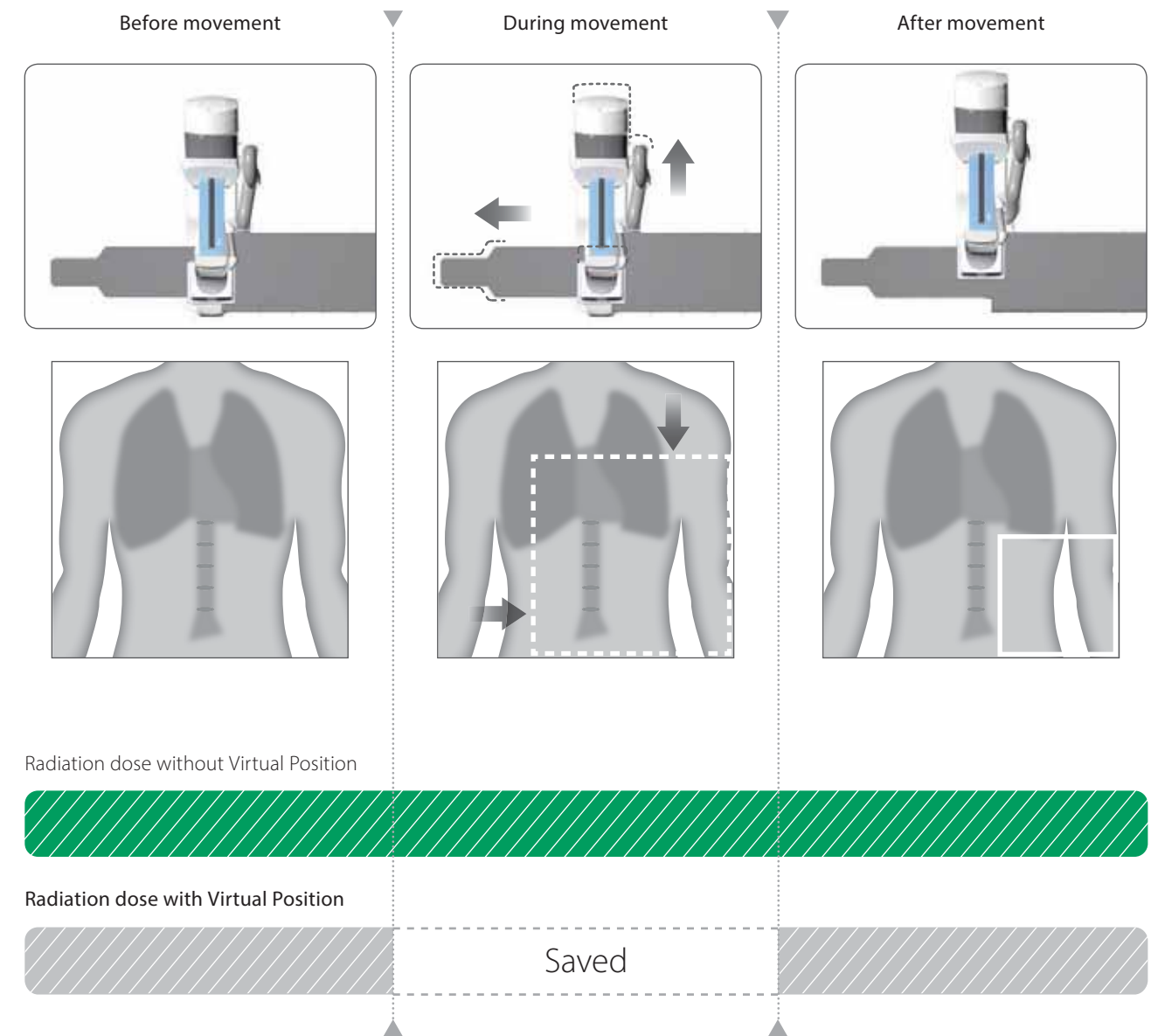

# Visualize estimated peak skin dose in realtime, and act on it.

## Dose Tracking System\* (DTS) Unique

### Visualize and record in realtime

Enhanced dose awareness is available through the DTS tool, providing estimated skin dose in realtime. Displayed as a 3D color map on a realistic patient graphic, this data can be used to exclude regions of previous high exposure both during and in subsequent procedures.

### Guide the procedure

Each patient's estimated peak skin dose is represented on a 3D color map. Live data can be displayed allowing the clinical staff to avoid regions of previous high exposure. During long procedures, such as PCI, CTO or EP, the operator can choose alternative approaches to optimize patient radiation dose while continuing the treatment.

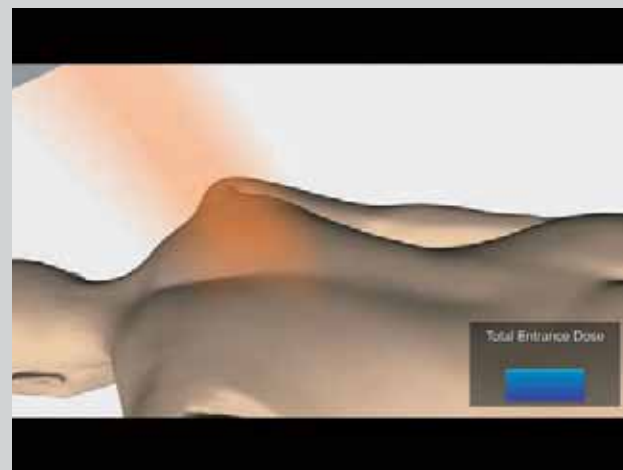

Standard system

DTS displays the estimated peak skin dose at specific regions in realtime in easy-to-identify color segments.

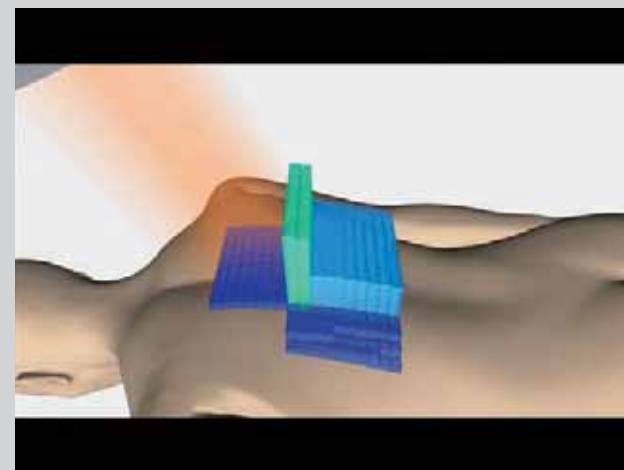

Dose Tracking System

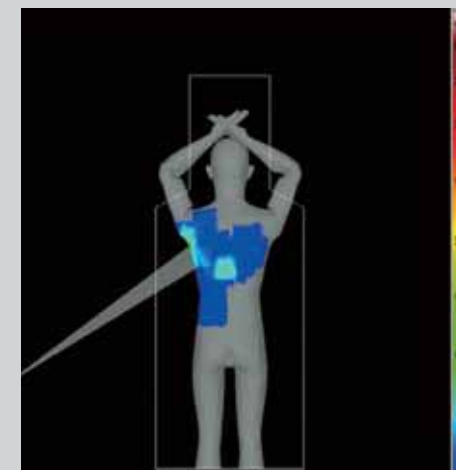

Visualize the accumulated estimated peak skin dose across the patient's body.

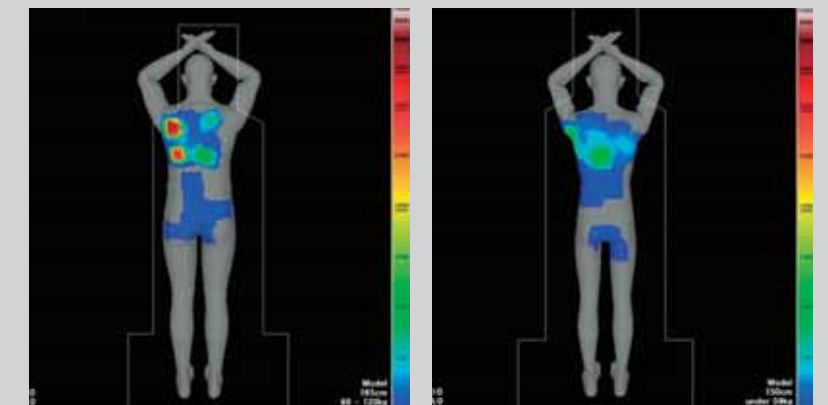

without DTS

with DTS

With DTS, the operator can chose different angulations during long procedures, such as CTO, to avoid regions.

# Work with unprecedented access.

Unique multi-access floor and ceiling mounted C-arm positioners were developed through extensive collaboration with leading clinicians. This resulted in designs that optimize C-arm positions in order to assist clinicians in providing optimal patient care.

## **Alphenix Core**

### FLOOR-MOUNTED SINGLE-PLANE SYSTEM

The compact C-arm system to provide high-resolution images for precise interventional procedures.

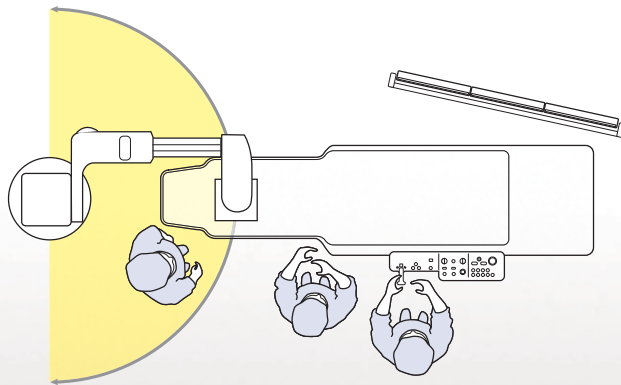

## **Alphenix Core+**

### FLOOR-MOUNTED MULTI-ACCESS SINGLE-PLANE SYSTEM

Providing flexible patient access, the 5-axis floor-mounted C-arm is ideally suited for a wide range of applications.

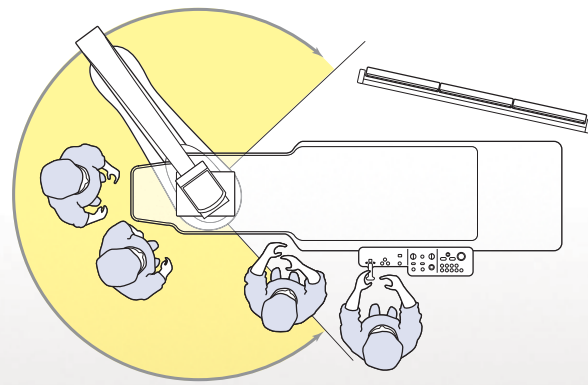

## **Alphenix Sky**

### CEILING-MOUNTED SYSTEM

Unique ceiling-mounted C-arm offers motorized longitudinal and lateral coverage to support upper extremity examinations.

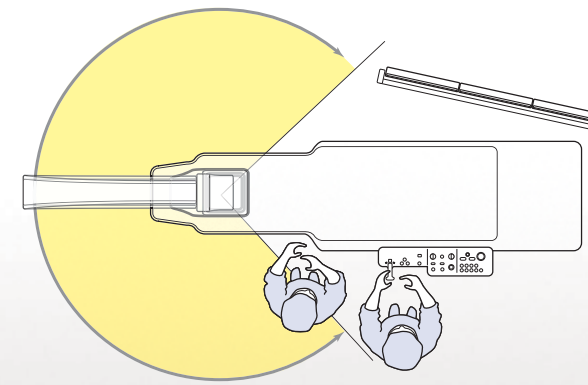

## **Alphenix Biplane**

### MULTI-ACCESS BIPLANE SYSTEM

Combining the exceptional flexibility of a floor-mounted and ceiling-mounted C-arm combination, the biplane system is an ideal choice for vascular and neuro diagnostic and interventional procedures.

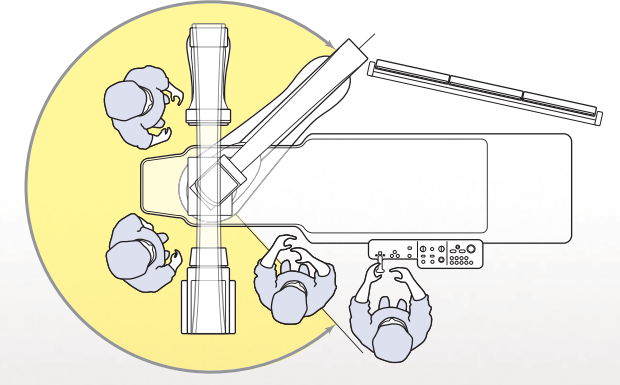

# Select the optimal lab for your clinical needs.

Alphenix interventional systems unique flexibility addresses your clinical needs, enhances your workflow, and optimizes patient care by providing multi access C-arms with a selection of three different size detectors.



## Detector size choices

Alphenix interventional angiography systems are available with a range of flat panel detector sizes to suit your coverage needs.

8" x 8"  
(20 cm x 20 cm)



12" x 12"  
(30 cm x 30 cm)



12" x 16"  
(30 cm x 40 cm)



## Fast, easy flat panel positioning

The flat panel detectors and the beam limiting devices mounted to the frontal and lateral systems are automatically rotated so that images are always displayed with the head end at the top of the monitor screen.



## Multiple table options

Designed to support your clinical practice using a hybrid approach to allow greater positioning flexibility in order to facilitate both endovascular and open surgical techniques.



Standard type



Tilting type



## How to Use the medicalAR App

Images with the  icon can be viewed in motion.

To download the app, scan the QR code or visit our website:

<https://global.medical.canon/about/medicalAR>

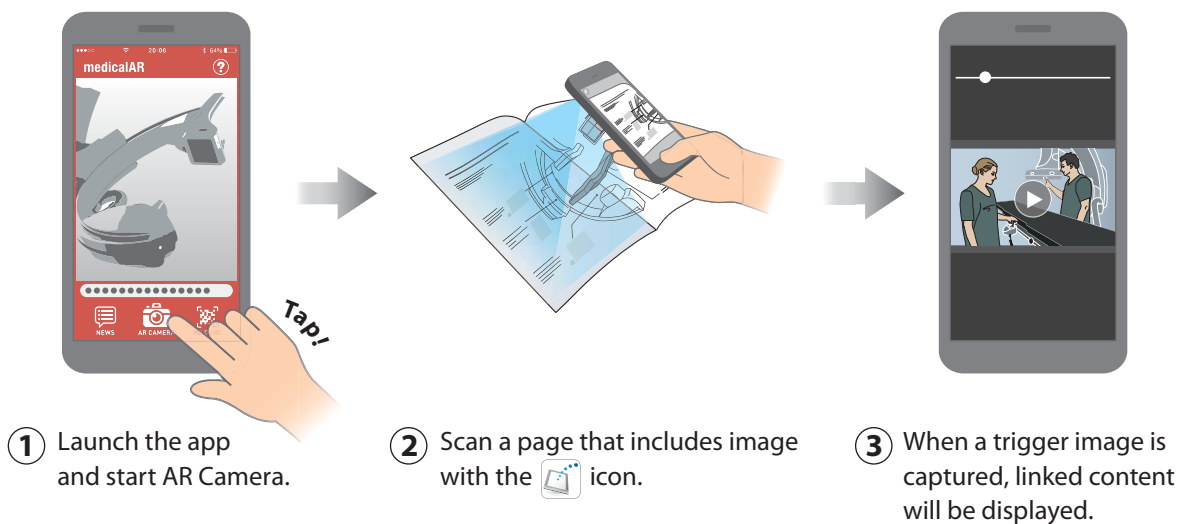

**Canon**

CANON MEDICAL SYSTEMS CORPORATION

<https://global.medical.canon>

©Canon Medical Systems Corporation 2018. All rights reserved.

Design and specifications are subject to change without notice.

Model number: INFX-8000V, INFX-8000C, INFX-8000F MCAXR0340EA 2018-12 CMSC/D/Printed in Japan

Canon Medical Systems Corporation meets internationally recognized standards for Quality Management System ISO 9001, ISO 13485. Canon Medical Systems Corporation meets the Environmental Management System standard ISO 14001.

Alphenix, DoseRite, Illuvis and Made for Life are trademarks of Canon Medical Systems Corporation.

Disclaimer: Some features presented in this brochure may not be commercially available on all systems shown or may require the purchase of additional options. Please contact your local representative from Canon Medical Systems for details.

*Made For life*